



Tecnostardue s.r.l.

impianti per l'industria della lavorazione carni



MONOROTAIA / CARRUOLE



Art. 1/00



CARRUCOLA PER BOVINI ZINCATA
CON LINCINO PARANCO, PIATTO 35x10, RUOTA Ø90 CON 2 CUSCINETTI ED INGRASSATORE, GANCIO Ø18 INOX AISI 420. PESO Kg. 2,500

GALVANIZED BEEF RUNNER
WITH TACKLE HOOK, FLAT IRON 35x10, WHEEL Ø90 WITH 2 BEARINGS AND GREASE NIPPLE, HOOK Ø18 AISI 420 STAINLESS STEEL WEIGHT 2,500 Kg.

Art. 1/20



CARRUCOLA PER BOVINI ZINCATA,
CON O SENZA LINCINO PARANCO, PIATTO 50x12, RUOTA Ø100 CON 2 CUSCINETTI ED INGRASSATORE, GANCIO Ø 18 INOX AISI 420. PESO Kg. 3,650

GALVANIZED BEEF RUNNER
WITH OR WITHOUT TACKLE HOOK, FLAT IRON 50x12, WHEEL Ø100 WITH 2 BEARINGS AND GREASE NIPPLE, HOOK Ø 18 AISI 420 STAINLESS STEEL, WEIGHT 3,650 Kg.

Art. 1/60



CARRUCOLA PER SUINI GIREVOLE ZINCATA
SENZA LINCINO PARANCO, PIATTO 30x8, RUOTA Ø80 CON 1 CUSCINETTO, GANCIO Ø12 INOX AISI 420. PESO 1,400 Kg.

GALVANIZED REVOLVING PORK RUNNER
WITH NO TACKLE HOOK, FLAT IRON 30x8, WHEEL Ø80 WITH 1 BEARING, HOOK Ø12 AISI 420 STAINLESS STEEL WEIGHT 1,400 Kg.

Art. 1/70



CARRUCOLA PER SUINI DOPPIO SNODO ZINCATA,
SENZA LINCINO PARANCO, PIATTO 30x8, RUOTA Ø 80 CON 1 CUSCINETTO, GANCIO Ø 12 INOX AISI 420.

GALVANIZED DOUBLE-JOINTED PORK RUNNER
WITH NO TACKLE HOOK, FLAT IRON 30x8, WHEEL Ø 80 WITH 1 BEARING, HOOK Ø12 AISI 420 STAINLESS STEEL

Tecnostardue s.r.l.
impianti per l'industria della lavorazione carni

VIA MODENA , 53 - 41014 - CASTELVETRO(MO) ITALY

TEL. +39.059.754.901 - FAX. +39.059.754.900 - E-mail : info@tecnostardue.it



Tecnostardue s.r.l.

impianti per l'industria della lavorazione carni



Art. 1/05

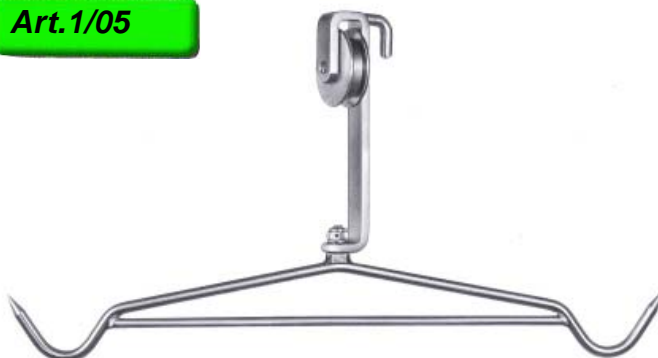

CARRUCOLA CON BILANCERE ZINCATA
CON UNCINO PARANCO, PIATTO 35x10, RUOTA Ø90 CON 2
CUSCINETTI ED INGRASSATORE, BILANCERE Ø14 INOX AISI 304

GALVANIZED RUNNER WITH GAMBREL
WITH TACKLE HOOK, FLAT IRON 35x10, WHEEL Ø90 WITH 2
BEARINGS AND GREASE NIPPLE, GAMBREL Ø14 AISI 304 STAINLESS
STEEL

Art. 1/93



CARRUCOLA PER OVINI ZINCATA
SENZA UNCINO PARANCO, PIATTO 30x8, RUOTA Ø80 CON 2
CUSCINETTI ED INGRASSATORE, GANCIO A FORCELLA INOX
AISI 304

GALVANIZED SHEEP RUNNER
WITH NO TACKLE HOOK, FLAT IRON 30x8, WHEEL Ø80 WITH
2 BEARINGS AND GREASE NIPPLE, FORK HOOK AISI 304
STAINLESS STEEL

Art. 1/80



CARRUCOLA LACCETTO
BOVINO ZINCATA
CON UNCINO PARANCO, PIATTO
60x15, RUOTA Ø120 CON 2
CUSCINETTI ED INGRASSATORE,
CATENA GENOVESE Ø6 CON
ANELLO

GALVANIZED BEEF SHACKLE
RUNNER
WITH TACKLE HOOK, FLAT IRON
60x15, WHEEL Ø120 WITH 2
BEARINGS AND GREASE NIPPLE,
TWISTED GENOISE CHAIN Ø6
WITH RING (CERTIFIED)

CARRUCOLA LACCETTO SUINO
ZINCATA
CON UNCINO PARANCO, PIATTO
35x10, RUOTA Ø90 CON 2
CUSCINETTI ED INGRASSATORE,
CATENA GENOVESE Ø6 CON
ANELLO

GALVANIZED PORK SHACKLE
RUNNER
WITH TACKLE HOOK, FLAT IRON
35x10, WHEEL Ø90 WITH 2
BEARINGS AND GREASE NIPPLE,
TWISTED GENOISE CHAIN Ø6 WITH
RING

Art. 1/90

Tecnostardue s.r.l.
impianti per l'industria della lavorazione carni

VIA MODENA , 53 - 41014 - CASTELVETRO(MO) ITALY

TEL. +39.059.754.901 - FAX. +39.059.754.900 - E-mail : info@tecnostardue.it



TecnoStardue s.r.l.
impianti per l'industria della lavorazione carni



**MONOROTAIA / SCAMBI
A DUE VIE**

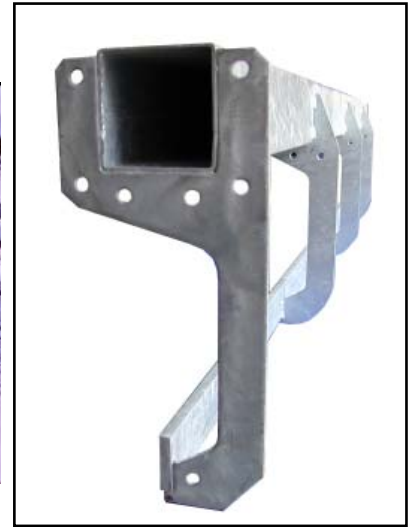

**AD AZIONAMENTO
SEMIAUTOMATICO**

Art.3/01



SCAMBIO DEL TIPO
ZINCATO
SWITCH TYPE
GALVANIZED

Art.3/51



SCAMBIO DEL TIPO
ZINCATO
SWITCH TYPE
GALVANIZED

Art.3/52



SCAMBIO DEL TIPO
ZINCATO
SWITCH TYPE
GALVANIZED

SEMIAUTOMATICO

TecnoStardue s.r.l.
impianti per l'industria della lavorazione carni

VIA MODENA , 53 - 41014 - CASTELVETRO(MO) ITALY

TEL. +39.059.754.901 - FAX. +39.059.754.900 - E-mail : info@tecnostardue.it



**MONOROTAIA / SCAMBI
A DUE VIE**

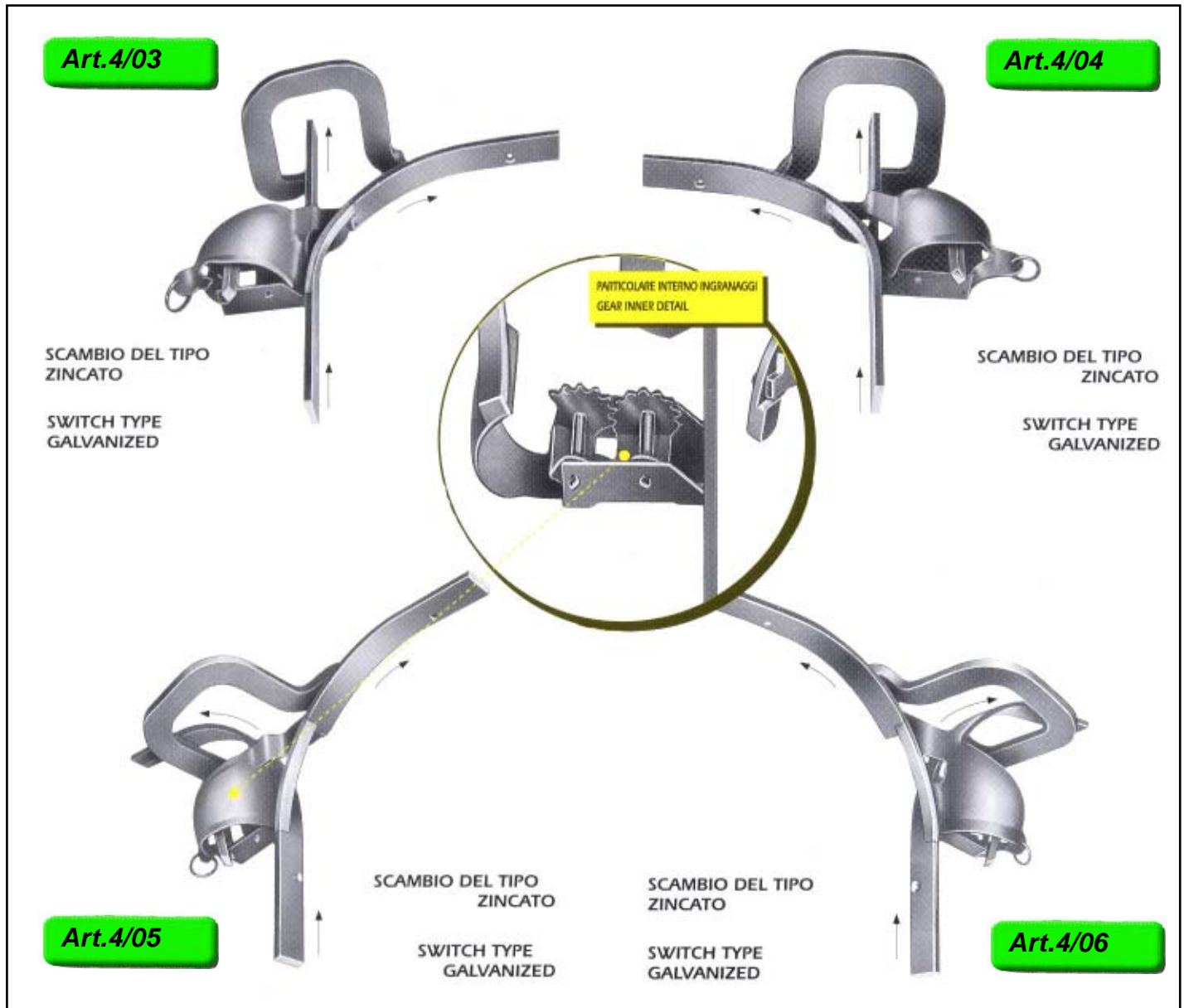

**SCAMBIO A DUE VIE CON AZIONAMENTO
AD INGRANAGGI CON CAVALLOTTO**



TecnoStardue s.r.l.
impianti per l'industria della lavorazione carni



MONOROTAIA / SCAMBI



A TRE E QUATTRO VIE AD AZIONAMENTO TRADIZIONALE

Art.3/57



SCAMBIO DEL TIPO ZINCATO
SWITCH TYPE GALVANIZED



Art.3/59

SCAMBIO DEL TIPO ZINCATO
SWITCH TYPE GALVANIZED

TecnoStardue s.r.l.
impianti per l'industria della lavorazione carni

VIA MODENA , 53 - 41014 - CASTELVETRO(MO) ITALY
TEL. +39.059.754.901 - FAX. +39.059.754.900 - E-mail : info@tecnostardue.it



TecnoStardue s.r.l.
impianti per l'industria della lavorazione carni



SCAMBIO A 4 VIE ROTATIVO CON AZIONAMENTO PNEUMATICO

Art. 1/93/1

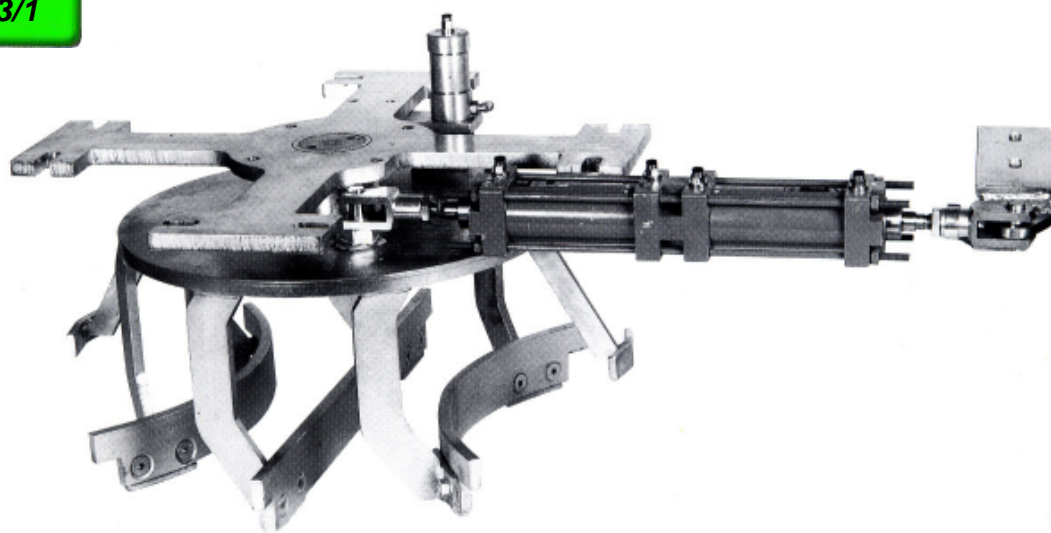

TecnoStardue s.r.l.
impianti per l'industria della lavorazione carni

VIA MODENA , 53 - 41014 - CASTELVETRO(MO) ITALY
TEL. +39.059.754.901 - FAX. +39.059.754.900 - E-mail : info@tecnostardue.it



MONOROTAIA / ACCESSORI

Art.6/04

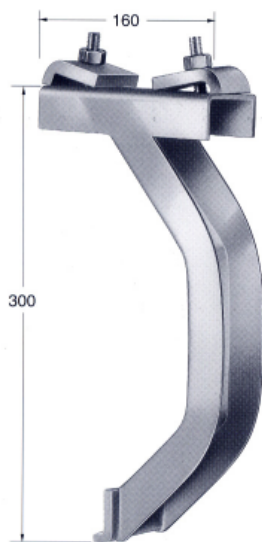

GRAFFA SAGOMATA AD "U" ZINCATA PER TRAVE HNP dal 120 al 160

GALVANIZED "U" SHAPED FASTENER FOR HNP from 120 to 160

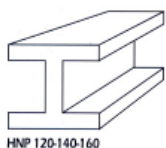

HNP 120-140-160



Art.6/00



GRAFFA ZINCATA PER TRAVE HNP 120/140/160

GALVANIZED FASTENER BEAM HNP 120-140-160

Art.6/02



GRAFFA PER TUBOLARE NON ZINCATA Ø100 SPESSORE 6 mm

FASTENER FOR ROUND BAR Ø100 THICKNESS 6 mm. NOT GALVANIZED



TecnoStardue s.r.l.

impianti per l'industria della lavorazione carni



Art.6/02/2

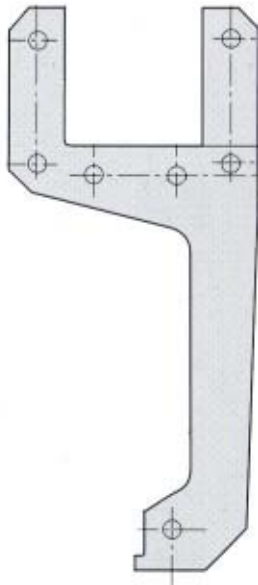

GRAFFA DI GIUNZIONE NON ZINCATA PER TUBOLARE \varnothing 100
SPESSORE 6 mm.

CONNECTION FASTENER FOR ROUND BAR
 \varnothing 100 THICKNESS 6 mm, NOT GALVANIZED

Art.6/07



CAVALLOTTO PER TUBO

\varnothing 100 IN TONDO FILETTATO MA16 COMPLETO DI PIASTRA
CON BULLONERIA, IN FERRO ZINCATO

U-BOLT FOR ROUND BAR

\varnothing 100 IN THREADED ROD 16 MA COMPLETE WITH PLATE
WITH NUTS AND BOLTS, ALL IN GALVANIZED FE.

Art.3/05

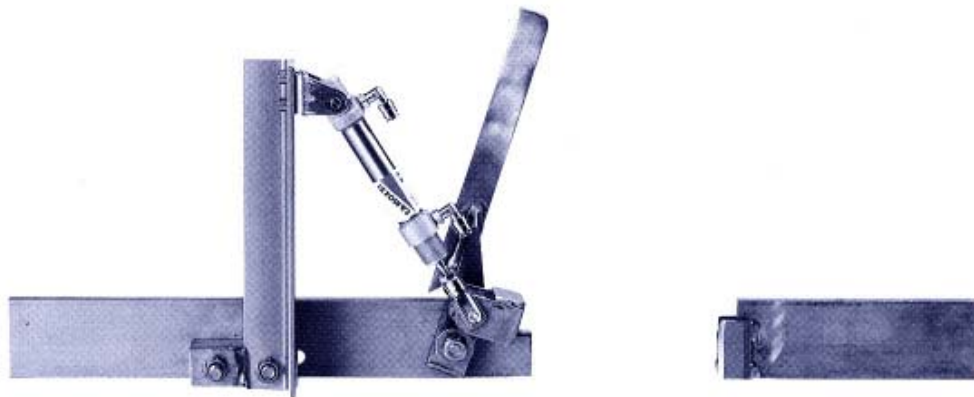

**INSERITORE MONOROTAIA CON FUNZIONAMENTO
PNEUMATICO PER PORTA CELLA FRIGORIFERA**

**MONORAIL CONNECTOR FOR COLD-STORAGE ROOM
DOOR WITH PNEUMATIC CONTROL**

TecnoStardue s.r.l.
impianti per l'industria della lavorazione carni

VIA MODENA , 53 - 41014 - CASTELVETRO(MO) ITALY

TEL. +39.059.754.901 - FAX. +39.059.754.900 - E-mail : info@tecnostardue.it